

DC-ATCO

Direct Current Thermal-Link (Alloy Type)

TD Series

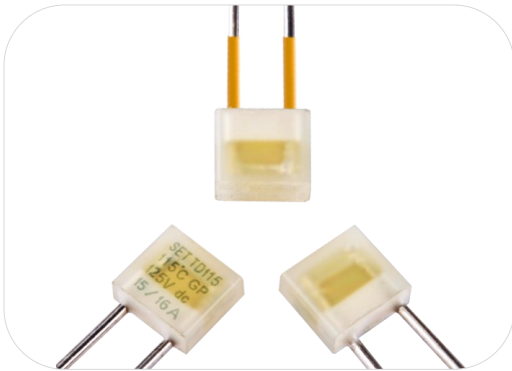

Description

The Direct Current Thermal-Link Alloy Type (DC-ATCO) is defined as a non-resettable protective device functioning one time only. It is widely used in electrical equipment. ATCO is mainly consist of fusible alloy, flux resin, case, sealant and lead wires. Normally, fusible alloy is jointed to the two lead wires. Under abnormal conditions, when the temp. reaches to the fusing temp. of ATCO, the fusible alloy melts and quickly retracts to the two lead wire ends with the aid of the flux resin and disconnects the circuit completely.

SETsafe | SETfuse Direct Current Thermal-Link Alloy Type (DC-ATCO) TD series Rated Functioning Temp. from 102 °C to 150 °C, Rated Current: 15 A,16 A, complies with RoHS and REACH.

Features

- Non-Resettable
- High Accuracy of Functioning Temp.
- RoHS & REACH Compliant

Applications

- Surge Protective Devices
- Switched-Mode Power Supplies
- Batteries

Customization

- Other Temp.
- The Length of Lead Wires
- Taping Packing Available
- Lead Wires can be Insulated
- Leads Forming Types

Structure Diagrams

Radial

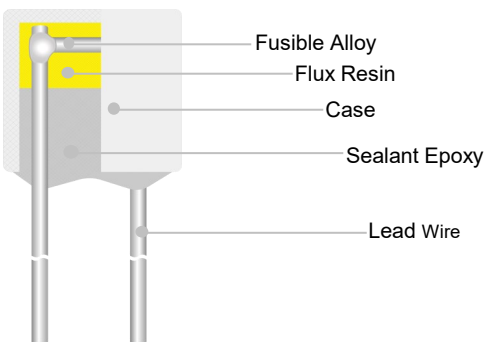

Marking

Radial (Color for reference only)

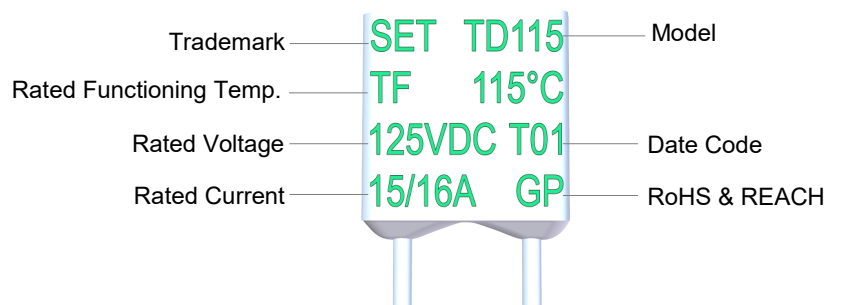

Remark: The Date Code means Year and quarter: A stands for 2000, B stands for 2001 and 01 stands for the first quarter, 02 stands for the second quarter, and so on.

Dimensions (mm)

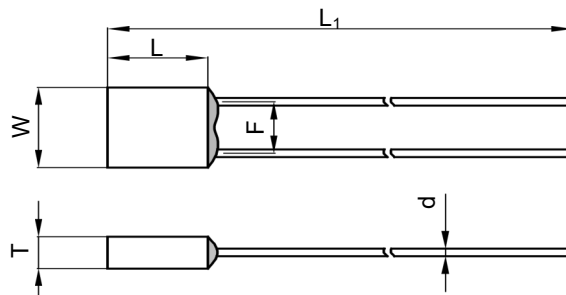

L	L ₁	W	T	d	F
7.5 ± 0.5	50.0 ± 2.0	8.6 ± 0.5	3.6 ± 0.2	1.05 ± 0.05	5.2 ± 0.5

Specifications

Rated Functioning Temp. (T_f) °C

	Model	Fusing Temp.	T_h	T_m	I_r	U_r	RoHS REACH
		(°C)	(°C)	(°C)	(A)	(V)	
150	TD150	145 ± 2	120	160	15 / 16	DC 125	●
136	TD136	131 ± 2	106	160	15 / 16	DC 125	●
130	TD130	125 ± 2	100	160	15 / 16	DC 125	●
125	TD125	121 ± 2	95	160	15 / 16	DC 125	●
115	TD115	111 ± 2	85	160	15 / 16	DC 125	●
102	TD102	98 ± 2	72	160	15 / 16	DC 125	●

Note:

- 1: "●"Means certificated, "○"Means non-certificated.
- 2: RoHS & REACH Compliant .

Soldering

Hand-Soldering

1. Soldering should be carried out according to Table T-1.
2. The thermal element of ATCO is fusible alloy with low melting point, which is jointed with ATCO lead wires. Improper soldering operation (too high soldering temp. , too long soldering time, too short lead wire etc.) may transfer more heat to the thermal element and ATCO may open in advance.
3. When soldering conditions are more severe than those listed in Table T-1, a heat sink fixture should be used between soldering point and ATCO body.
4. When soldering, please do not pull / push or twist ATCO body or lead wires.
5. After soldering, let it naturally cool for longer than 20 seconds. During cooling, never move the ATCO body or lead wires.

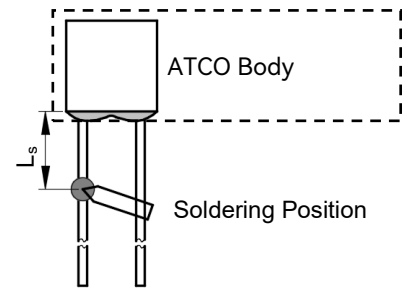

FIGURE T-1

TABLE T-1 Hand-Soldering Time

Rated Functioning Temp. (T_f)	Max. Allowable Soldering Time for Different Lead Wire Length (Fig.T-1)									Max. Soldering Temp.
	L_s Length	Time		L_s Length	Time		L_s Length	Time		
		Tinned Copper Wire	CP Wire		Tinned Copper Wire	CP Wire		Tinned Copper Wire	CP Wire	
(°C)	(mm)	(s)	(s)	(mm)	(s)	(s)	(mm)	(s)	(s)	(°C)
102 to 115	10	1 ^a	4	20	2	5	30	3	6	400
116 to 135	10	1 ^a	4	20	3	6	30	5	8	
136 to 150	10	3	6	20	5	8	30	5	8	

Note:

a: Auxiliary Heat Sink Fixture is Required to Avoid ATCO Cutting off Unexpectedly.

DC-ATCO

Direct Current Thermal-Link (Alloy Type)

TD Series

Wave Soldering

The wave soldering parameters as Table T-2, for reference only, when ATCO is for practice use, you need to do some validation experiments. For example, using X-RAY to see the fusible alloy of ATCO whether damage after wave soldering.

TABLE T-2 Wave Soldering Parameters Setting

Rated Functioning Temp. (T_f)	Max. Allowable Preheating Temp. When the Length of Lead Wire is Different (Fig.T-1)				Preheating Time (t_1)	Max. Wave Soldering Temp.	Dwelling Time (t_2)	Cooling Time (t_3)
	L_s Length	Preheating Temp.	L_s Length	Preheating Temp.				
(°C)	(mm)	(°C)	(mm)	(°C)	(s)	(°C)	(s)	(s)
102 to 130	建议手工焊接							
131 to 150	20	80	30	90	< 60	≤ 260	≤ 3	≤ 10

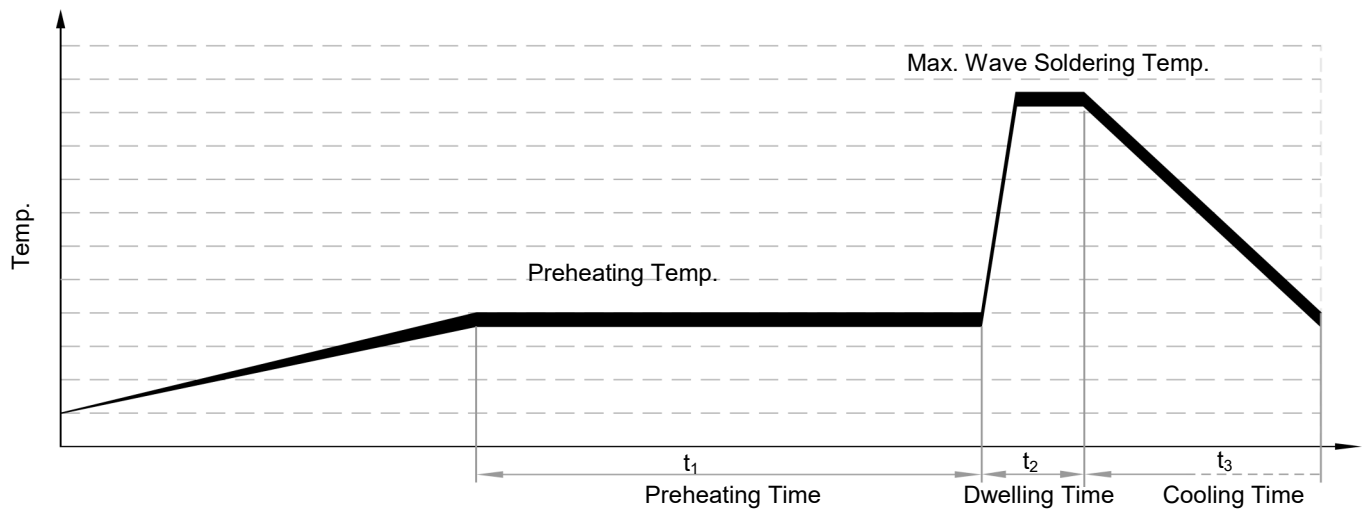

Product Temp.-Time Curve (Reference)

The Temp.-Time Curve of Thermal-Link in different temp. oil bath.

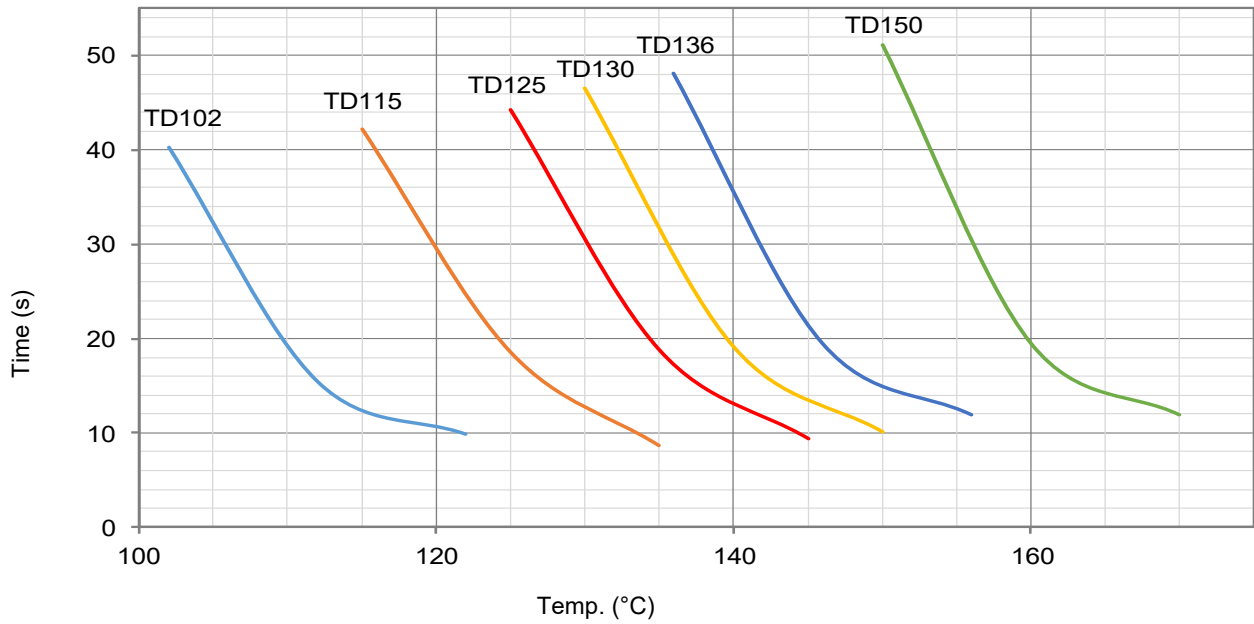

Product Current-Time Curve (Reference)

The Current-Time Curve shows functioning time at multi-times rated current at room temperature $25 \pm 2 \text{ }^\circ\text{C}$.

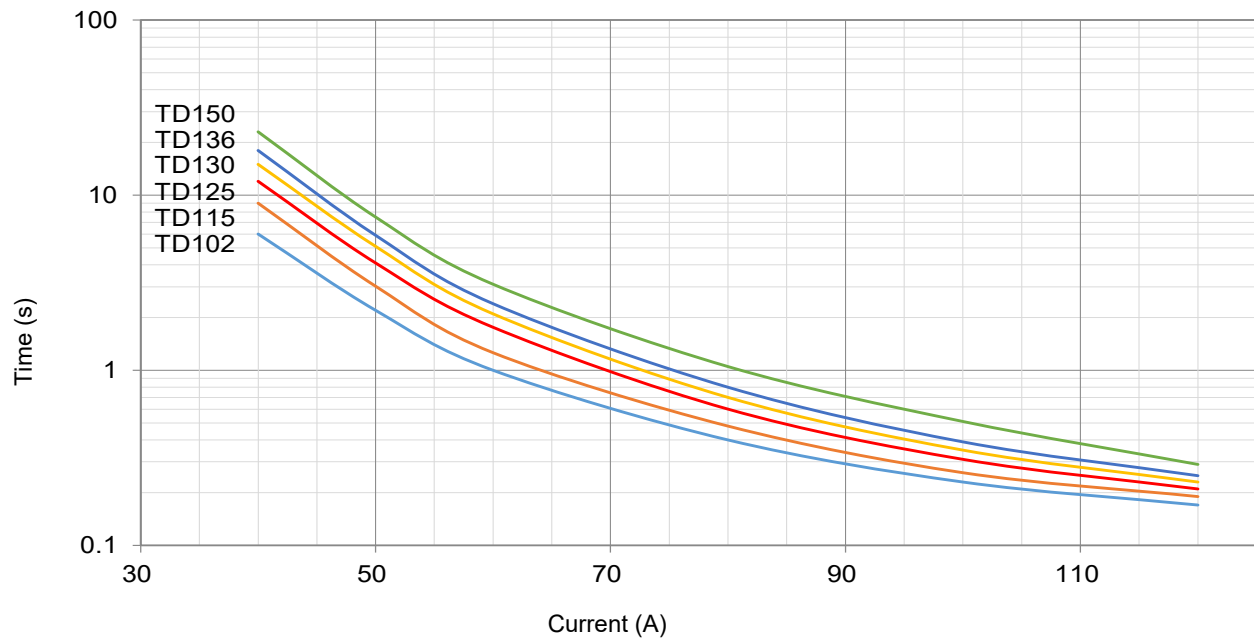

DC-ATCO

Direct Current Thermal-Link (Alloy Type)

TD Series

Packaging Information

Bulk

Item	PE Bag	PE Bag	Carton
Dimensions (mm)	135 × 85	190 × 180	440 × 300 × 260
Quantity (PCS)	50	500	20000
Gross Weight (kg)			22.0 ± 10%

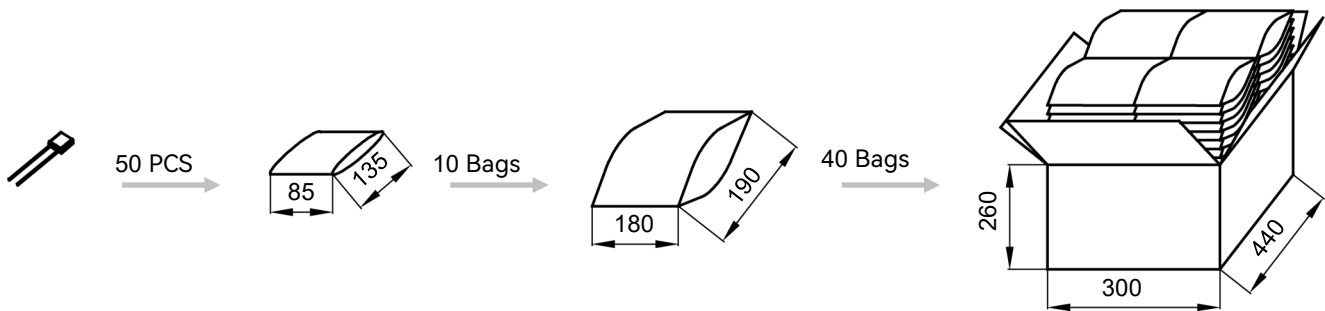

Taping

Item	Box	Carton
Dimensions (mm)	328 × 200 × 70	480 × 340 × 220
Quantity (PCS)	2000	12000
Gross Weight (kg)	14.0 ± 10%	

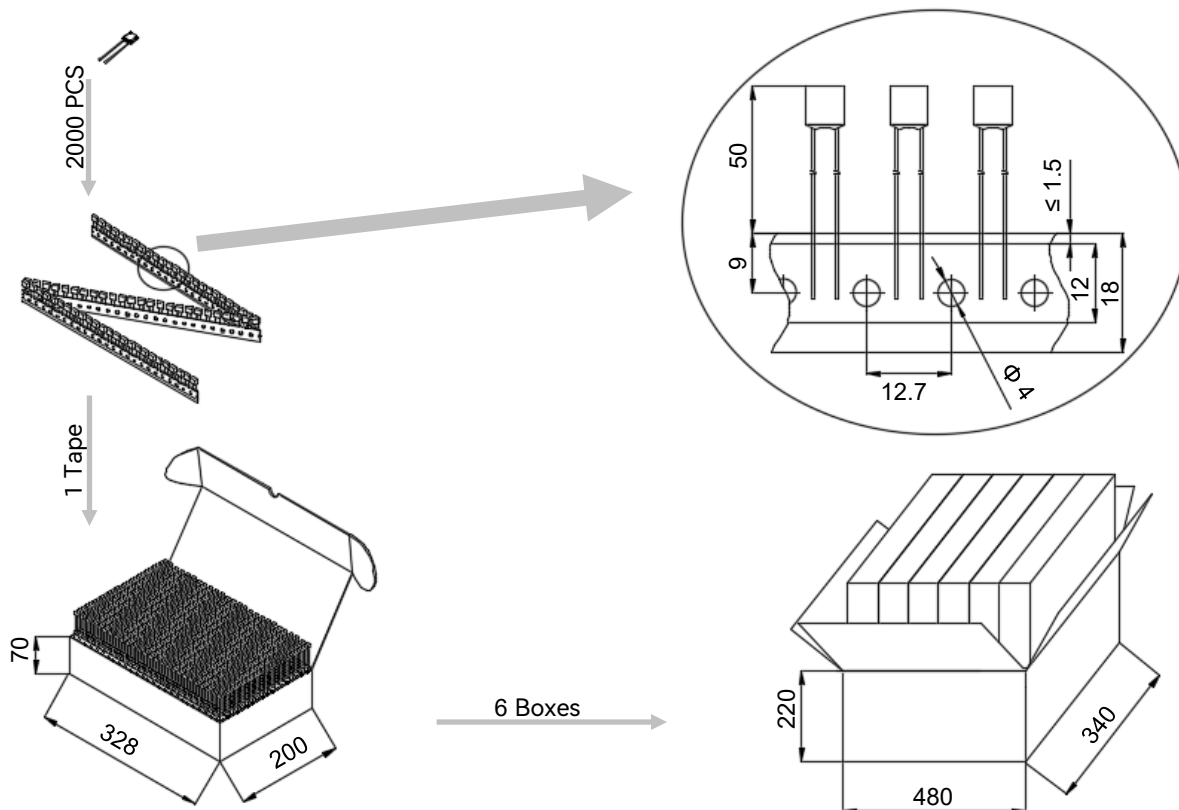

DC-ATCO

Direct Current Thermal-Link (Alloy Type)

TD Series

Part Numbering System

ATCO – TD115 - A N N A B - 001



Glossary

Item	Description
TCO	<p>Thermal-Link A non-resettable device incorporating a THERMAL ELEMENT which will open a circuit once only when exposed for a sufficient length of time to a temperature in excess of that for which it has been designed.</p> <p style="text-align: right;">— (GB 9816.1)</p>
ATCO	<p>Alloy Thermal-Link Alloy Type Thermal-Link, Alloy is the thermal element.</p> <p style="text-align: right;">— (GB 9816.1)</p>
T_f	<p>Rated Functioning Temp. The temperature of the Alloy Thermal-Link which causes it to change the state of conductivity with a detection current up to 10 mA as the only load.</p> <p style="text-align: right;">— (GB 9816.1)</p> <p>Tolerance: T_f °C (GB 9816.1, EN 60691, K60691). Tolerance: $T_f \pm 7$ °C (J60691).</p>
Fusing Temp.	<p>Fusing Temp. The temperature of the Alloy Thermal-Link which causes it to change its state of conductivity is measured with silicone oil bath in which the temperature is increased at the rate of 0.5 °C to 1 °C / minute, with a detection current up to 10 mA as the only load.</p> <p style="text-align: right;">— (GB 9816.1)</p>
T_h	<p>Holding Temp. The Maximum temperature at which a Alloy Thermal-Link will not change its state of conductivity when conducting rated current for 168 hours.</p> <p style="text-align: right;">— (GB 9816.1)</p>
T_m	<p>Maximum Temp. Limit The temperature of the Alloy Thermal-Link stated by the manufacturer, up to which the mechanical and electrical properties of the Alloy Thermal-Link having changed its state of conductivity, will not be impaired for a given time.</p> <p style="text-align: right;">— (GB 9816.1)</p>
I_r	<p>Rated Current The current used to classify a Alloy Thermal-Link, which is the Maximum current that Alloy Thermal-Link allows to carry and is able to cut off the circuit safely.</p> <p style="text-align: right;">— (GB 9816.1)</p>
U_r	<p>Rated Voltage The voltage used to classify a Alloy Thermal-Link, which is the Maximum voltage that Alloy Thermal-Link allows to carry and is able to cut off the circuit safely.</p> <p style="text-align: right;">— (GB 9816.1)</p>
I_n	<p>Nominal Discharge Current Being able to withstand 15 peak currents of waveform 8/20 μs to test the product's durability of withstanding pulse current.</p> <p style="text-align: right;">— (UL 1449)</p>
I_{max}	<p>Max. Discharge Current Being able to withstand 1 peak current of waveform 8/20 μs to test max. pulse current that the product can withstand.</p> <p style="text-align: right;">— (UL 1449)</p>



ATTENTION

Usage

1. When atmosphere pressure is from 80 kPa to 106 kPa, the related altitude shall be from 2000 meters to - 500 meters.
2. Operating voltage less than rated voltage of ATCO, operating current less than rated current of ATCO.
3. Do not touch the ATCO body or lead wires directly when power is on, to avoid burn or electric shock.

Replace

ATCO is a non-repairable product. For safety sake, it shall be replaced by an equivalent ATCO from the same manufacturer, and mounted in the same way.

Storage

Do not store the ATCO at the high temp., high humidity or corrosive gas environment, avoid influencing the solder-ability of the lead wires, the product shall be used up within 1 year after receiving the goods.

Installation

Make Sure the Temp. of Installation Position.

1. It is recommended that a dummy ATCO with inbuilt thermo-couple shall be used to determine the proper temp.
2. The terminal product should be tested to ensure that potential abnormal conditions do not cause ambient temp. to exceed the T_m of the ATCO.
3. Mount the ATCO at the location where temp. rises evenly.

Installation position of mechanical performance requirements.

1. Do not locate the ATCO in a place where severe vibration always occurs.
2. Ensure that the lead wire is long enough, and avoid actions such as press, tensile or twist.
3. The seal or body of ATCO must not be damaged, burned or over heated.

Mechanical Connection

Riveting

1. Choose small resistivity riveting material and be riveted.
2. A flexible lead or lead with low resistance should be used to rivet the ATCO.
3. Contact resistance should be minimal, large contact resistance will lead to higher temp., ATCO Functioning in advance.

Crimping

1. Choose small resistivity crimping material and be crimped.
2. A flexible lead or lead with low resistance should be used to rivet the ATCO.
3. Contact resistance should be minimal, large contact resistance will lead to higher Temp., ATCO Functioning in advance.

Lead Wire Forming

1. If lead wire has to be bent, please pay attention to the distance between body and bending point. Refer to Table T-3.
2. When bending leads, please use pincher or similar tools to fix the product as shown in Fig.T-2, to avoid damaging the product.
3. During forming and mounting, lead wire should not be cut, nicked, bent sharply, to avoid breaking the product.
4. Tangential forces on the leads must be avoided (i.e. pushing or pulling on the leads at angle to ATCO body) as such forces may damage the seal of ATCO.

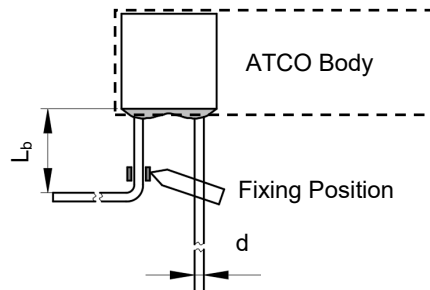

FIGURE T-2

TABLE T-3 Distance between Body and Bending Point

Circular lead	d	(mm)	< 1.0	1.0 - 1.2	> 1.2
	L_b	(mm)	≥ 3	≥ 5	≥ 10

DC-ATCO

Direct Current Thermal-Link (Alloy Type)

TD Series







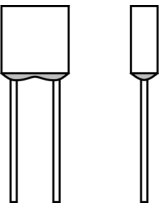
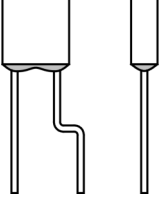
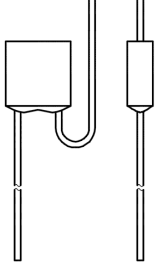
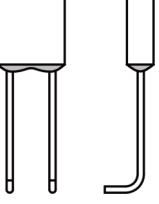
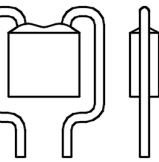
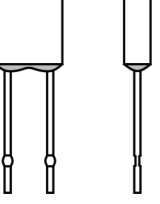
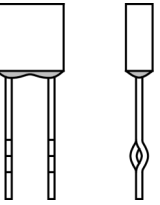
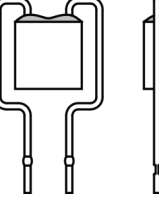
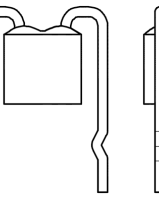

Leads Forming Types

The below leads forming is for reference, more leads forming can be customized.



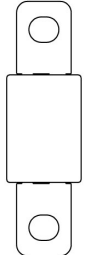
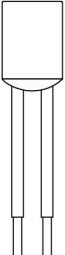

Radial

A	B	C	D	E
	 	 	 	 

Direct Current Thermal-Link Alloy Type (DC-ATCO) Features & Model List Overview

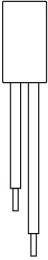
Rated Functioning Temp. (T _r) °C	Model								
	TGH187-HVS [^]	ASL187A-LSF [^]	RSK187A-KSS [^]	RVH187-HSF [^]	ARL187-LRA [^]			RQF187-FQS [^]	
230	○	○	○	○	○	○	○	○	○
221	○	○	○	○	○	○	○	○	○
205	○	○	○	○	○	○	○	○	○
200	○	○	○	○	○	○	○	○	○
187	TGH187-HVS [^]	ASL187A-LSF [^]	RSK187A-KSS [^]	RVH187-HSF [^]	ARL187-LRA [^]	○	○	RQF187-FQS [^]	○
160	○	○	○	○	○	○	○	○	○
150	TGH150-HVS [^]	ASL150A-LSF [^]	RSK150A-KSS [^]	RVH150-HSF [^]	ARL150-LRA [^]	RPK150-HRZ [^]	TG150C-HQZ [^]	RQF150-FQS [^]	TG150C-JPZ [^]
145	○	○	○	○	○	○	○	○	○
139	○	○	○	○	○	○	○	○	○
136	TGH136-HVS [^]	ASL136A-LSF [^]	RSK136A-KSS [^]	RVH136-HSF [^]	ARL136-LRA [^]	RPK136-HRZ [^]	TG136C-HQZ [^]	RQF136-FQS [^]	TG136C-JPZ [^]
135	○	○	○	○	○	○	○	○	○
133	○	○	○	○	○	○	○	○	○
130	TGH130-HVS [^]	○	○	RVH130-HSF [^]	○	○	○	RQF130-FQS [^]	○
125	TGH125-HVS [^]	ASL125A-LSF [^]	RSK125A-KSS [^]	RVH125-HSF [^]	ARL125-LRA [^]	RPK125-HRZ [^]	TG125C-HQZ [^]	RQF125-FQS [^]	TG125C-JPZ [^]
123	○	○	○	○	○	○	○	○	○
120	○	○	○	○	○	○	○	○	○
115	TGH115-HVS [^]	ASL115A-LSF [^]	RSK115A-KSS [^]	RVH115-HSF [^]	ARL115-LRA [^]	RPK115-HRZ [^]	TG115C-HQZ [^]	RQF115-FQS [^]	TG115C-JPZ [^]
105	○	○	○	○	○	○	○	○	○
102	TGH102-HVS [^]	ASL102A-LSF [^]	RSK102A-KSS [^]	RVH102-HSF [^]	ARL102-LRA [^]	RPK102-HRZ [^]	TG102C-HQZ [^]	RQF102-FQS [^]	TG102C-JPZ [^]
97	○	○	○	○	○	○	○	○	○
93	○	○	○	○	○	○	○	○	○
86	○	○	○	○	ARL86-LRA [^]	○	TG86C-HQZ [^]	RQF86-FQS [^]	○
76	○	○	○	○	○	○	○	○	○
I_r (A) Rated Current	15	30	25	15	30	15	15	10	20
U_r (VDC)[^] Rated Voltage	850		600		500		450		400
U_r (VAC)[*] Rated Voltage	○	○	○	○	○	○	○	○	○
Product Structure									
	Axial Shape	Radial Shape	Radial Shape	Radial Shape	Axial Shape	Radial Shape	Axial Shape	Radial Shape	Axial Shape

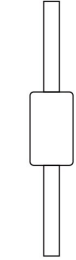
Direct Current Thermal-Link Alloy Type (DC-ATCO) Features & Model List Overview

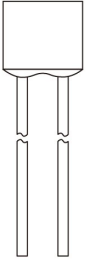
Rated Functioning Temp. (T_r) °C	Model											
	TG150C-JSZ*				HN150^*	HP150^*	HS150^*		QD150^A	PD150^A	TD150^A	SD150^A
230	○	○	○	○	○	○	○	○	○	○	○	○
221	○	○	○	○	○	○	○	○	○	○	○	○
205	○	○	○	○	○	○	○	○	○	○	○	○
200	○	○	○	○	○	○	○	○	○	○	○	○
187	○	○	○	○	○	○	○	○	○	○	○	○
160	○	○	○	○	○	○	○	○	○	○	○	○
150	TG150C-JSZ*	○	○	○	HN150^*	HP150^*	HS150^*	○	QD150^A	PD150^A	TD150^A	SD150^A
145	○	○	○	○	○	○	○	○	○	○	○	○
139	○	○	○	○	○	○	○	○	○	○	○	○
136	TG136C-JSZ*	○	○	○	HN136^*	HP136^*	HS136^*	○	QD136^A	PD136^A	TD136^A	SD136^A
135	○	○	○	○	○	○	○	○	○	○	○	○
133	○	○	○	○	○	○	○	○	○	○	○	○
130	○	○	○	○	○	○	○	○	QD130^A	PD130^A	TD130^A	SD130^A
125	TG125C-JSZ*	○	○	○	HN125^*	HP125^*	HS125^*	ALP125-PLZ^A	QD125^A	PD125^A	TD125^A	SD125^A
123	○	○	○	○	○	○	○	○	○	○	○	○
120	○	○	○	○	○	○	○	○	○	○	○	○
115	TG115C-JSZ*	○	○	ALP115-HLZ^A	○	○	○	○	QD115^A	PD115^A	TD115^A	SD115^A
105	○	○	○	○	○	○	○	○	○	○	○	○
102	TG102C-JSZ*	○	○	○	○	○	○	ALP102-PLZ^A	QD102^A	PD102^A	TD102^A	SD102^A
97	○	○	○	○	○	○	○	○	○	○	○	○
93	○	○	○	○	○	○	○	○	○	○	○	○
86	○	TG86C-HSZ*	RPF86-FPF^A	○	○	○	○	○	○	○	○	○
76	○	○	○	○	○	○	○	○	○	○	○	○
I_r (A) Rated Current	20	15	10	15	15	10	5	60	20	15 16	10	25
U_r (VDC)^A Rated Voltage	○	○	400	○	200	○	○	180	○	○	125	○
U_r (VAC)^* Rated Voltage	600	○	○	○	690	500	○	○	○	○	○	○
Product Structure												
	Axial Shape	Radial Shape	Radial Shape	Radial Shape	Axial Shape	Radial Shape						



Direct Current Thermal-Link Alloy Type (DC-ATCO) Features & Model List Overview

Rated Functioning Temp. (T_f) °C	Model													
	Q136**	Q136*	Q136*	P136**	P136*	P136*	TB136-UHZ^A	TB136-UJZ*	TS136-RHZ^A	TS136-RJZ*	S136^A	T136^A	ADN230B-NEZ	
230	○	○	○	○	○	○	○	○	○	○	○	○	○	○
221	○	○	○	○	○	○	○	○	○	○	○	○	○	○
205	○	○	○	○	○	○	○	○	○	○	○	○	○	○
200	○	○	○	○	○	○	○	○	○	○	○	○	○	○
187	○	○	○	○	○	○	○	○	○	○	○	○	○	○
160	○	○	○	○	○	○	○	○	○	○	○	○	○	○
150	○	○	○	○	○	○	○	○	○	○	S150^A	T150^A	○	○
145	○	○	○	○	○	○	○	○	○	○	○	○	○	○
139	○	○	○	○	○	○	○	○	○	○	○	○	○	○
136	○	○	○	○	○	○	○	○	○	○	○	○	○	○
135	○	○	○	○	○	○	○	○	○	○	○	○	○	○
133	○	○	○	○	○	○	○	○	○	○	○	○	○	○
130	○	○	○	○	○	○	○	○	○	○	○	○	○	○
125	○	○	○	○	○	○	○	○	○	○	○	○	○	○
125	Q125**	○	○	P125**	○	○	TB125-UHZ^A	TB125-UJZ*	TS125-RHZ^A	TS125-RJZ*	○	○	○	○
123	○	○	○	○	○	○	○	○	○	○	○	○	○	○
120	○	○	○	○	○	○	○	○	○	○	○	○	○	○
115	Q115**	Q115*	Q115*	P115**	P115*	P115*	TB115-UHZ^A	TB115-UJZ*	TS115-RHZ^A	TS115-RJZ*	S115^A	T115^A	○	○
105	○	○	○	○	○	○	○	○	○	○	○	○	○	○
102	Q102**	○	○	P102**	P102*	P102*	TB102-UHZ^A	TB102-UJZ*	TS102-RHZ^A	TS102-RJZ*	S102^A	T102^A	○	○
97	○	○	○	○	○	○	○	○	○	○	○	○	○	○
93	○	○	○	○	○	○	○	○	○	○	○	○	○	○
86	○	○	○	○	○	○	○	○	○	○	○	○	○	○
76	○	○	○	○	○	○	○	○	○	○	○	○	○	○
I_r (A) Rated Current	25			20			200		100		10	15 16	50	
U_r (VDC)^A Rated Voltage	120						100	○	100	○	100	60		
U_r (VAC)* Rated Voltage	400	300	250	400	300	250	○	125	○	125	○	○		
Product Structure														
							Radial Shape						Axial Shape	

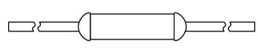
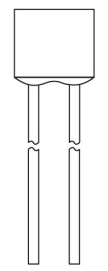
Direct Current Thermal-Link Alloy Type (DC-ATCO) Features & Model List Overview

Rated Functioning Temp. (T _r) °C	Model																						
	R31^*	U31^*						C31^*					B31^*	H31^*	V31^*	V31^*		X31^*	K31^*				
230	○	○	○	○	○	○	○	○	○	○	○	○	○	○	○	○	○	○	○	○	○		
221	R32^*	○	U32^*	○	○	○	○	○	C32^*	○	○	○	○	B32^*	○	H32^*	V32^*	V32^*	○	○	X32^*	K32^*	○
205	○	○	○	○	○	○	○	○	○	○	○	○	○	○	○	○	○	○	○	○	○	○	○
200	○	○	○	○	○	○	○	○	○	○	○	○	○	○	○	○	○	○	○	○	○	○	○
187	○	○	○	○	○	○	○	○	○	○	○	○	○	○	○	○	○	○	○	○	X17^*	K17^*	○
160	R16^*	○	U16^*	○	○	○	○	○	C16^*	○	○	○	○	○	H16^*	V16^*	○	○	○	○	X16^*	K16^*	F16^*
150	R7^*	○	U7^*	○	○	○	○	○	○	○	○	○	○	○	○	○	○	○	○	○	X7^*	K7^*	F7^*
145	R6^*	○	U6^*	C6^*	○	○	○	○	○	○	○	X6^*	○	○	○	○	○	K6^*	F6^*	X6^*	K6^*	F6^*	
139	○	CR13^*	○	○	M13^*	C13^*	○	○	○	SF13^*	V13^*	○	○	○	○	○	○	○	F13^*	○	○	○	F13^*
136	○	○	○	○	○	○	○	○	○	○	○	X9^*	○	○	○	○	○	K9^*	○	X9^*	K9^*	○	○
135	R5^*	○	U5^*	○	○	○	○	○	○	○	○	○	○	○	○	○	○	○	○	○	X5^*	K5^*	○
133	○	○	○	○	○	○	○	○	○	○	V8^*	SF8^*	○	○	○	○	○	○	○	F8^*	X8^*	K8^*	F8^*
130	R4^*	○	U4^*	○	○	○	○	○	○	○	V4^*	SF4^*	○	○	○	○	○	○	○	F4^*	X4^*	K4^*	F4^*
125	R3^*	○	U3^*	○	○	○	○	○	○	○	○	○	○	○	H3^*	○	○	○	○	○	X3^*	K3^*	F3^*
123	○	○	○	○	○	○	○	○	○	○	○	○	○	○	○	○	○	○	○	○	○	○	○
120	○	○	○	○	○	○	○	○	○	○	○	○	○	○	○	○	○	○	○	○	○	○	○
115	R2^*	○	U2^*	○	○	○	C2^*	○	○	○	V2^*	SF2^*	○	○	○	○	○	○	○	F2^*	X2^*	K2^*	F2^*
105	○	○	○	○	○	○	○	○	○	○	○	○	○	○	○	○	○	○	○	○	○	○	○
102	R1^*	○	U1^*	○	○	○	○	○	○	○	○	○	○	○	○	○	○	○	○	F1^*	X1^*	K1^*	F1^*
97	○	○	○	○	○	○	○	○	○	○	○	○	○	○	○	○	○	○	○	○	○	○	○
93	○	○	○	○	○	○	○	○	○	○	○	○	○	○	○	○	○	○	○	○	○	○	○
86	R18^*	○	U18^*	○	○	○	○	C18^*	○	○	○	○	○	V18^*	○	○	○	○	○	F18^*	X18^*	K18^*	F18^*
76	R0^*	○	U0^*	○	○	○	○	○	○	○	○	○	○	○	○	○	○	○	○	○	X0^*	K0^*	F0^*
I_r (A) Rated Current		15	10	9	8.5	8	6	5	4	3	2.5	2	1	4	3	2	1						
U_r (VDC)^* Rated Voltage		60																					
U_r (VAC)^* Rated Voltage		250	○	250	○	○	○	250	○	○	250	○	○	250	125	○	○	○	○	○	250	○	○
Product Structure		 <p>Axial Shape</p>											 <p>Radial Shape</p>										

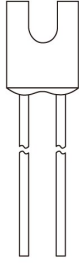
Direct Current Thermal-Link Alloy Type (DC-ATCO) Features & Model List Overview

Rated Functioning Temp. (T _r) °C	Model														
	XG31*	KG31*			C31*		B31*		H31*		ADN230B-NDZ ^Δ	ADN230B-PDZ ^Δ		ADN230B-QBZ ^Δ	
230	○	○	○	○	○	○	○	○	○	○	○	○	○	○	
221	XG31*	KG31*	○	○	C31*	○	B31*	○	H31*	○	○	○	○	ADN205B-NDZ ^Δ	
205	XG32*	KG32*	○	○	C33*	○	B32*	○	H32*	○	○	○	○	○	
200	○	○	○	○	○	○	○	○	○	○	○	○	○	○	
187	○	○	○	○	○	○	○	○	○	○	○	○	○	○	
160	XG16*	KG16*	○	○	○	B16*	○	○	○	○	○	○	○	○	
150	XG7*	KG7*	C7 ^Δ	C7*	○	B7 ^Δ	○	H7 ^Δ	○	V7 ^Δ	○	○	○	○	
145	XG6*	KG6*	C6 ^Δ	C6*	○	B6 ^Δ	○	H6 ^Δ	○	V6 ^Δ	○	○	○	○	
139	○	○	C13 ^Δ	C13*	○	B13 ^Δ	○	H13 ^Δ	○	V13 ^Δ	○	○	○	○	
136	XG9*	KG9*	C9 ^Δ	C9*	○	B9 ^Δ	○	H9 ^Δ	○	V9 ^Δ	○	○	○	○	
135	XG5*	KG5*	C5 ^Δ	C5*	○	B5 ^Δ	○	H5 ^Δ	○	V5 ^Δ	○	○	○	○	
133	XG8*	KG8*	C8 ^Δ	C8*	○	B8 ^Δ	○	H8 ^Δ	○	V8 ^Δ	○	○	○	○	
130	XG4*	KG4*	C4 ^Δ	C4*	○	B4 ^Δ	○	H4 ^Δ	○	V4 ^Δ	○	○	○	○	
125	XG3 ^Δ *	KG3 ^Δ *	C3 ^Δ	C3*	○	B3 ^Δ *	○	○	○	V3 ^Δ *	○	○	○	○	
123	○	○	○	○	○	○	○	○	○	○	○	○	○	○	
120	○	○	○	○	○	○	○	○	○	○	○	○	○	○	
115	XG2 ^Δ *	KG2 ^Δ *	C2 ^Δ	C2*	○	B2 ^Δ *	○	H2 ^Δ *	○	V2 ^Δ *	○	○	○	○	
105	○	○	○	○	○	○	○	○	○	○	○	○	○	○	
102	XG1 ^Δ *	KG1 ^Δ *	○	C1 ^Δ *	C1*	B1 ^Δ *	B1*	H1 ^Δ *	H1*	V1 ^Δ *	V1*	○	○	○	
97	○	○	○	○	C21 ^Δ *	○	B21 ^Δ *	○	H21 ^Δ *	○	V21 ^Δ *	○	○	○	
93	○	○	○	○	○	○	○	○	○	○	○	○	○	○	
86	XG18 ^Δ *	KG18 ^Δ *	○	C18 ^Δ *	C18*	B18 ^Δ *	B18*	H18 ^Δ *	H18*	V18 ^Δ *	V18*	○	○	○	
76	XG0*	KG0*	○	C0*	○	B0 ^Δ *	B0*	H0 ^Δ *	H0*	V0 ^Δ *	V0*	○	○	○	
I_r (A) Rated Current	3	2	7	5	3	2	1	50	55	50	80				
U_r (VDC)^Δ Rated Voltage	60		50					49	48		24				
U_r (VAC)[*] Rated Voltage	250		○	250	125	250	125	250	125	250	125	○			
Product Structure	 Radial Shape					 Axial Shape					